

405nm 200mW Multi-mode Fiber Coupled Laser Diode

Features:

- 405nm
- 105um Multi-Mode Fiber
- Coaxial or HHL-01 Package
- Photodiode Optional
- TE Cooler Optional

Applications:

- Medical Laser Treatment
- Biological Laser
- Others



WAVESPECTRUM can offer high stability fiber coupled laser module. The fiber types can be single-mode fiber (SMF), polarization maintaining fiber (PMF) and multimode fiber (MMF). We choose the world's top level laser chips in making the lasers to ensure the high quality. And the lasers will undergo severe restricted aging and testing before sending to the customer. At present, we can offer the pigtailed laser products with the wavelength range of 375nm ~ 1920nm, and the output power range is from 1mW to 50W. We adopt the unique technical scheme to makes the laser and the lasers are of high stability and low noise. For single-mode fiber (SMF) and polarization maintaining fiber (PMF) coupling laser, the light spot is single transverse mode Gaussian beam. And the polarization extinction ratio can reach greater than 20dB (PER) as per customer's requirements.





WAVESPECTRUM can offer various wavelengths listed as below:: 375nm, 405nm, 445nm/450nm, 465nm, 488nm, 505nm/510nm, 515nm/520nm/525nm, 633nm, 635nm/638nm/640nm/642nm, 650nm/658nm/660nm, 670nm, 685nm/690nm, 705nm, 730nm, 755nm/760nm/770nm, 780nm/785nm, 795nm, 800nm/808nm/810nm, 820nm/830nm, 840nm/850nm/860nm, 880nm, 905nm,915nm, 940nm, 976nm/980nm, 1060nm/1064nm, 1210nm, 1270nm, 1280nm, 1290nm, 1310nm, 1330nm, 1350nm, 1370nm, 1390nm, 1410nm, 1430nm, 1450nm, 1470nm, 1490nm, 1510nm, 1530nm, 1550nm, 1570nm, 1590nm, 1610nm, 1625nm, 1650nm, 1720nm, 1900nm, 1920nm.

WAVESPECTRUM can provide a variety of laser products: single mode laser diode, multimode laser diode, single mode fiber coupling laser modules, polarization maintaining fiber coupled laser modules, multi-mode pigtailed laser modules, fiber detachable laser module, RGB white fiber coupled laser module, medical laser module, turnkey fiber coupled laser system, etc. The main packages for the lasers can be: TO18 | TO5 | C-mount | TO3 | E-mount | H-mount | COS | 2-pin | 4-pin | 9-pin | 14-pin.

WAVESPECTRUM - welcome to to inquiry any time!

Pls visit our Website for more info.: <http://www.wavespectrum-laser.com.cn/index.html>

MORE CHOICES, MORE IDEAS

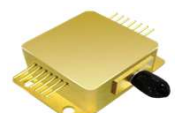
     												
Laser Diode	Fiber Coupled Laser Module			Fiber Receptacle LD			Laser System		RGB Pigtailed White Laser		Medical Laser Module	
375nm	405nm	445nm	465nm	488nm	505nm	520nm	525nm	635nm	650nm	660nm	670nm	680nm
685nm	760nm	785nm	790nm	808nm	830nm	850nm	860nm	880nm	905nm	915nm	940nm	980nm
1064nm	1210nm	1270nm	1280nm	1290nm	1310nm	1330nm	1350nm	1370nm	1390nm	1410nm	1430nm	1450nm
1470nm	1490nm	1510nm	1530nm	1550nm	1570nm	1590nm	1610nm	1625nm	1650nm	1720nm	1900nm	1920nm
WAVESPECTRUM LASER GROUP LIMITED Email: sales@wavespectrum-laser.com.cn Tel.: +86 22 8793 1118 Web.: http://en.wavespectrum-laser.com.cn												



405nm 200mW Multi-mode Fiber Coupled Laser Diode

Part Number	WSLP-405-200m-105M		
PARAMETER	SYMBOL	VALUE	UNIT OF MEASURE
Reverse Voltage	V_r	2.0	V
Operating Temperature	T_{op}	0~+50	°C
Storage Temperature	T_{stg}	-40~+85	°C
Lead Soldering Temperature (10 sec.)	T_{ls}	260	°C
Typical Specification (@25°C)		Min.	Typical Value
Optical Specifications	Center Wavelength	405nm+/-10nm	
	Output Power	----	200mW
	Spectral Width(FWHM)	----	2.0nm
	Wavelength Temp. Coefficient	0.05nm/°C	
	Laser Type	FP	
Fiber Specifications	Fiber Core	105um	
	N.A.	0.22	
	Fiber Type	Multi-mode Fiber	
	Fiber Length	>80cm	
	Fiber Connector	FC/SMA905/SC/ST	
Electrical Specifications	Threshold Current	----	130mA
	Operating Current	----	320mA
	Operating Voltage	----	4.5V
Photodiode Specifications	Photodiode	Without	
	PD Current	----	----
	PD Reverse Voltage (Max.)	----	
TE Cooler Specifications	TEC Current (Max.)	----	
	TEC Voltage (Max.)	----	
Thermistor	Thermistor (@25°C)	----	
Other Specifications	Package	Coaxial or HHL-01	
	Recommended Operating Temp.	25°C	



405nm 200mW Multi-mode Fiber Coupled Laser Diode

Product Package View:

Coaxial Package View:

(Part Number: WSLP-405-200m-105M)

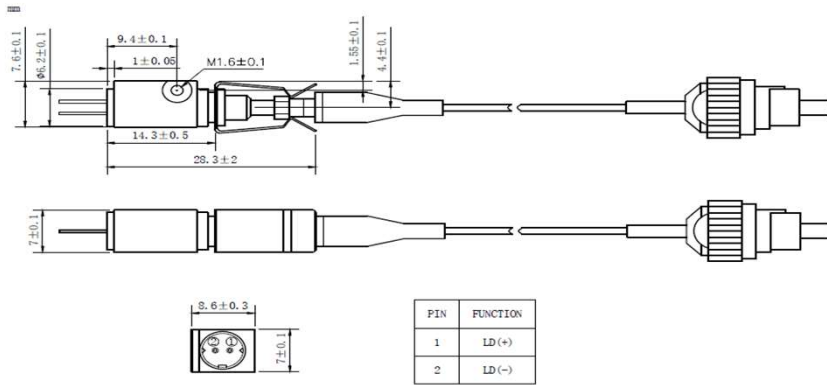

HHL-01 Package View:

(Part Number: WSLX-405-200m-105M-H-T)

