

635nm 700mW Multimode Laser Diode

Features:

- 638nm
- Multimode
- TO18 Package
- Whithout Photodiode

Applications:

- Medical Laser Treatment
- Biological Laser
- Others



WAVESPECTRUM offers high quality laser diodes, including single-mode laser diodes (SMLD) and multi-mode laser diodes (MMLD), according to different spot patterns. To ensure high quality requirements of laser diodes, we adopt the world's top laser chips for making each laser diode, and the laser diodes will undergo severe aging and various testing before sending to the customer. At present, our company can provide laser diode products with the wavelength range of 405nm ~ 1920nm, and the optical power range is from 10mW to 15W. The main package includes TO38, TO18, TO5, TO3, C-mount, E-Mount, COS and HHL window package. The PD backlight and TE Cooler is optional as per the customer's requirements.





WAVESPECTRUM can offer various wavelengths listed as below::

375nm, 405nm, 445nm/450nm, 465nm, 488nm, 505nm/510nm, 515nm/520nm/525nm, 633nm, 635nm/638nm/640nm/642nm, 650nm/658nm/660nm, 670nm, 685nm/690nm, 705nm, 730nm, 755nm/760nm/770nm, 780nm/785nm, 795nm, 800nm/808nm/810nm, 820nm/830nm, 840nm/850nm/860nm, 880nm, 905nm,915nm, 940nm, 976nm/980nm, 1060nm/1064nm, 1210nm, 1270nm, 1280nm, 1290nm, 1310nm, 1330nm, 1350nm, 1370nm, 1390nm, 1410nm, 1430nm, 1450nm, 1470nm, 1490nm, 1510nm, 1530nm, 1550nm, 1570nm, 1590nm, 1610nm, 1625nm, 1650nm, 1720nm, 1900nm, 1920nm.

WAVESPECTRUM can provide a variety of laser products: single mode laser diode, multimode laser diode, single mode fiber coupling laser modules, polarization maintaining fiber coupled laser modules, multi-mode pigtailed laser modules, fiber detachable laser module, RGB white fiber coupled laser module, medical laser module, turnkey fiber coupled laser system, etc. The main packages for the lasers can be: TO18 | TO5 | C-mount | TO3 | E-mount | H-mount | COS | 2-pin | 4-pin | 9-pin |14-pin.

WAVESPECTRUM - welcome to inquiry any time!
 Pls visit our Website for more info.: <http://www.wavespectrum-laser.com.cn/index.html>

MORE CHOICES, MORE IDEAS

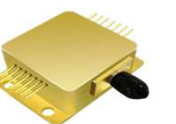
													
Laser Diode		Fiber Coupled Laser Module			Fiber Receptacle LD			Laser System		RGB Pigtailed White Laser		Medical Laser Module	
375nm	405nm	445nm	465nm	488nm	505nm	520nm	525nm	635nm	650nm	660nm	670nm	680nm	
685nm	760nm	785nm	790nm	808nm	830nm	850nm	860nm	880nm	905nm	915nm	940nm	980nm	
1064nm	1210nm	1270nm	1280nm	1290nm	1310nm	1330nm	1350nm	1370nm	1390nm	1410nm	1430nm	1450nm	
1470nm	1490nm	1510nm	1530nm	1550nm	1570nm	1590nm	1610nm	1625nm	1650nm	1720nm	1900nm	1920nm	

WAVESPECTRUM LASER GROUP LIMITED

Email: sales@wavespectrum-laser.com.cn
 Tel.: +86 22 8793 1118
 Web.: <http://en.wavespectrum-laser.com.cn>



635nm 700mW Multimode Laser Diode

Part Number	WSLD-635-700m-1		
PARAMETER	SYMBOL	VALUE	UNIT OF MEASURE
Reverse Voltage	V_r	2.0	V
Operating Temperature	T_{op}	-10~+40	°C
Storage Temperature	T_{stg}	-40~+85	°C
Lead Soldering Temperature (10 sec.)	T_{is}	260	°C
Typical Specification (@25°C)	Min.	Typical Value	Max.
Optical Parameters	Center Wavelength	638nm+/-10nm	
	Output Power	----	700mW
	Spectral Width(FWHM)	----	2.0nm
	Wavelength Temp. Coefficient	0.2nm/°C	
	Laser Type	FP	
	Beam Type	Multimode	
	Emitter Size	40um x 1um	
	Beam Divergence (FWHM)	$23^\circ \perp \times 2^\circ //$	$35^\circ \perp \times 7.5^\circ //$
Electrical Parameters	Slope Efficiency	----	1.0mW/mA
	Threshold Current	----	180mW
	Operating Current	----	250mW
Photodiode Parameters	Operating Voltage	----	950mW
	Operating Voltage	----	2.3V
	Operating Voltage	----	2.7V
Photodiode Parameters	Photodiode	Without PD	
	PD Current	----	----
	PD Reverse Voltage (Max.)	----	
Other Parameters	Package	TO18 (5.6mm)	
	Recommended Operating Temp.	25°C	

Product Package View:

TO18 (5.6mm) Package:

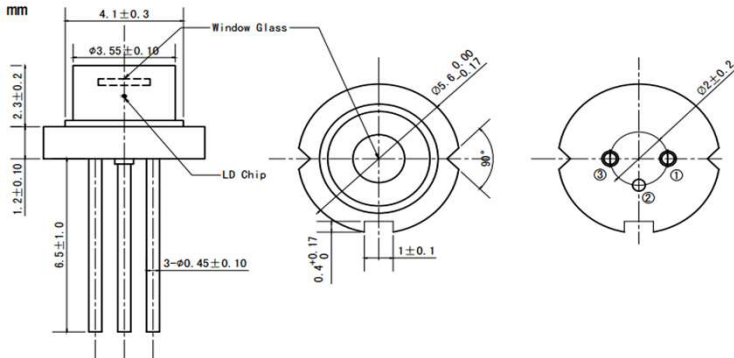

PIN Bottom View:

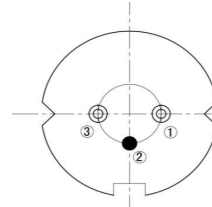

Pin-1	LD(+)
Pin-2	CASE
Pin-3	LD(-)

