

980nm 20mW SM Coaxial Pigtailed Laser Diode with 6um SMF | Built-in PD
976nm~980nm 20mW SM Fiber Coupled LD with Single Mode Fiber (SM Fiber) | With Photodiode
WSLP-980-020m-4-PD
Wavespectrum Laser Group
www.wavespectrum-laser.com

980nm Pigtailed Diode Laser		20mW/SM Fiber		en.wavespectrum-laser.com.cn
PARAMETER	SYMBOL	VALUE	UNIT	
Reverse Voltage	V_r	2.0	V	
Operating Temperature	T_{op}	-10~+50	°C	
Storage Temperature	T_{stg}	-40~+85	°C	
Lead soldering temperature (10 sec.)	T_{is}	260	°C	
Features: <ul style="list-style-type: none"> ● 976nm ● 6um SM Fiber ● Coaxial or B82 Package ● Built-in PD 				
Applications: <ul style="list-style-type: none"> ● Medical Laser Treatment ● Others 				
Specifications	WSLP-980-020m-4-PD			
	Min	Type	Max	
Center Wavelength@25°C	±5nm	976nm	±15nm	
Recommended Operating Temperature	25°C			
Output Power	----	20mW	----	
Fiber Type	Single Mode Fiber			
Fiber Core	6um			
Monitor Current	----	0.2mA	----	
PD Reverse Voltage	----	----	30V	
Fiber Connector	FC/SC/SMA905			
Fiber Length	----	80cm	100cm	
Threshold Current (Typ.)	----	20mA	45mA	
Operating Current (Typ.)	----	125mA	140mA	
Operating Voltage	----	1.9V	2.6V	
Package Style	Coaxial or B82			
Photodiodes	Built-in			

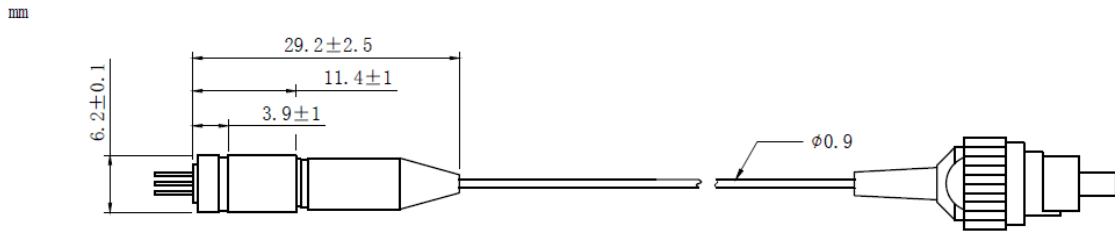
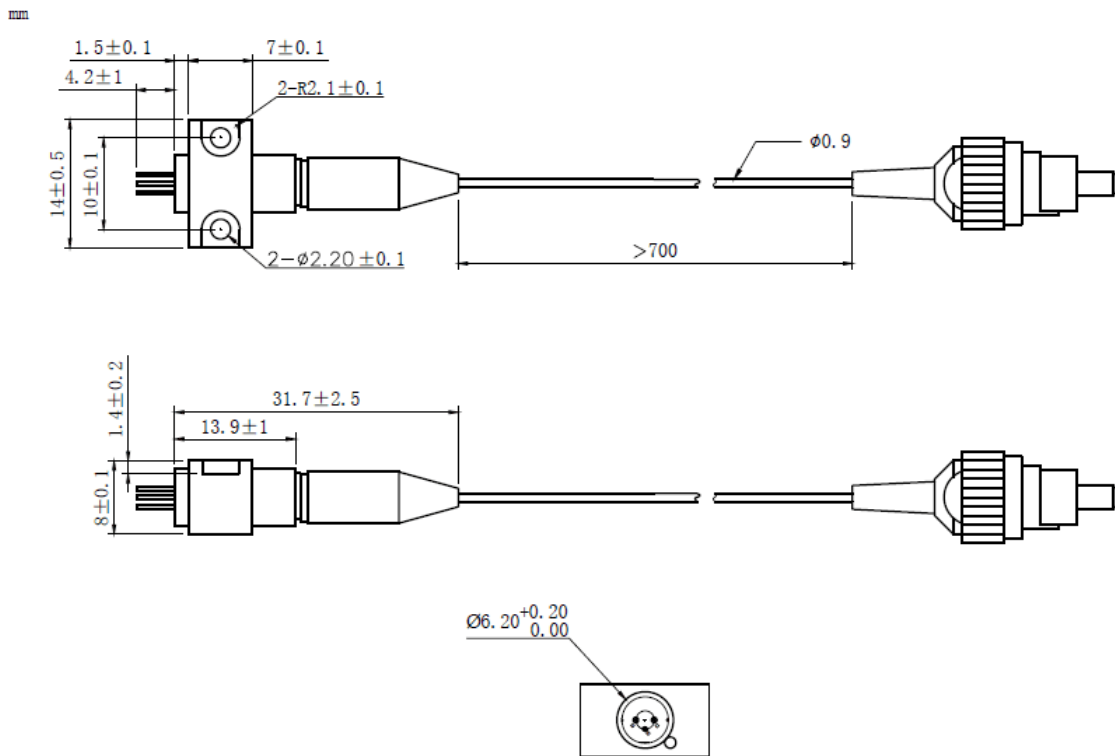
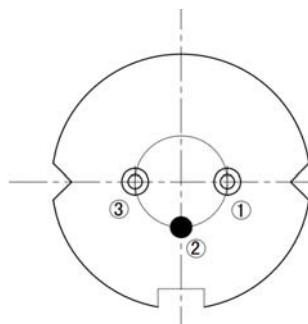

Coaxial Package View: (Part Number: WSLP-980-020m-4-PD)

B82 Package View: (Part Number: WSLP-980-020m-4-B-PD)

PIN Bottom View:

PIN 1	LD(-)
PIN 2	LD(+)&PD(-), CASE
PIN 3	PD(+)



Electrically shorten LD module and store in non-extreme conditions.
Suggest using the constant current power supply.

