

650nm~660nm 100mW SM Fiber Coupled Laser Diode with 4um Single Mode Fiber
658nm 100mW High Power Pigtailed Diode Laser with Coaxial Package | High Power SM Red LD Module
WSLP-650-100m-4
Wavespectrum Laser Group
www.wavespectrum-laser.com

650nm Pigtailed Diode Laser		100mW/SM Fiber		Wavespectrum Laser Group	
PARAMETER	SYMBOL	VALUE		UNIT	
Reverse Voltage	V_r	2.0		V	
Operating Temperature	T_{op}	-10~+60		°C	
Storage Temperature	T_{stg}	-40~+85		°C	
Lead soldering temperature (10 sec.)	T_{is}	260		°C	
Features: <ul style="list-style-type: none"> 650nm Single Mode Fiber Coaxial or B82 Package 					
Applications: <ul style="list-style-type: none"> Medical Laser Treatment Other 					
Specifications		WSLP-650-100m-4			
	Min	Type	Max		
Center Wavelength@25°C	±5nm	658nm	±10nm		
Spectral Width (FWHM)	----	2.0nm	----		
Output Power	----	100mW	----		
Fiber Type	Single Mode Fiber				
Fiber Core	4um				
Recommend Operating Temperature	25°C				
Fiber Connector	FC/SC/SMA905				
Fiber Length	----	80cm	100cm		
Threshold Current	----	55mA	85mA		
Operating Current	----	220mA	240mA		
Operating Voltage	----	2.8V	3.5V		
Package Style	Coaxial or B82				

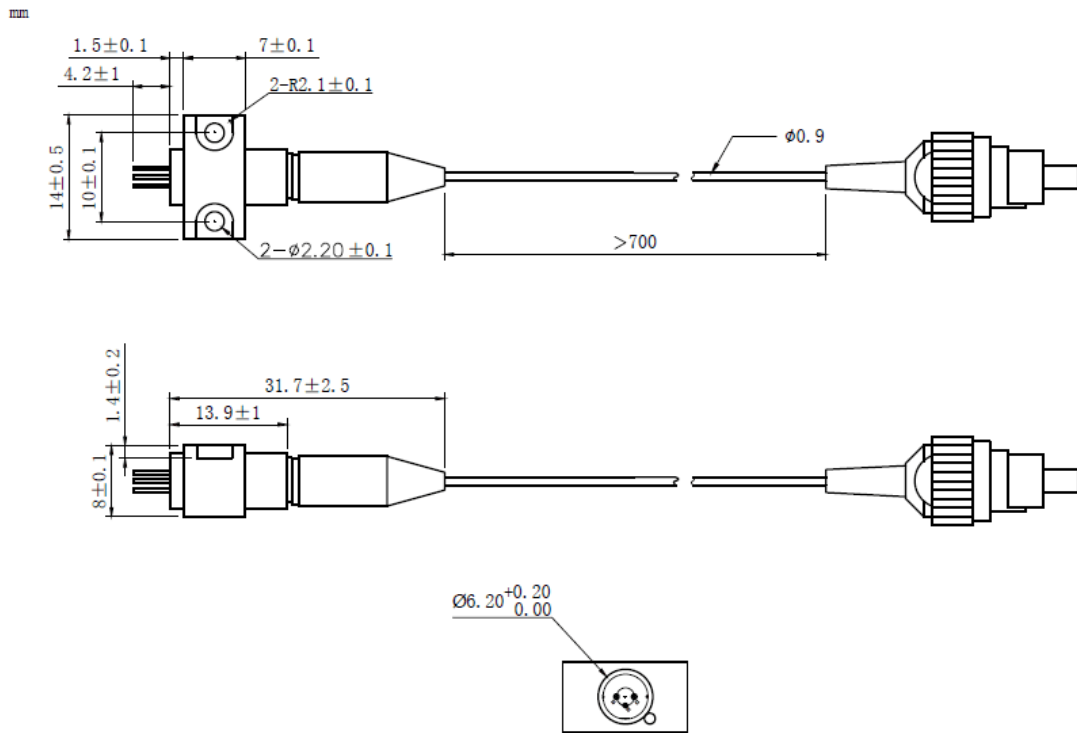
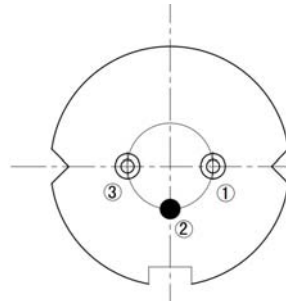

Coaxial Package View: (Part Number: WSLP-650-100m-4)

B82 Package View: (Part Number: WSLP-650-100m-4-B)

PIN Bottom View:

1	LD(+)
2	LD(-)
3	NC



Electrically shorten LD module and store in non-extreme conditions.
Suggest using the constant current power supply.

